

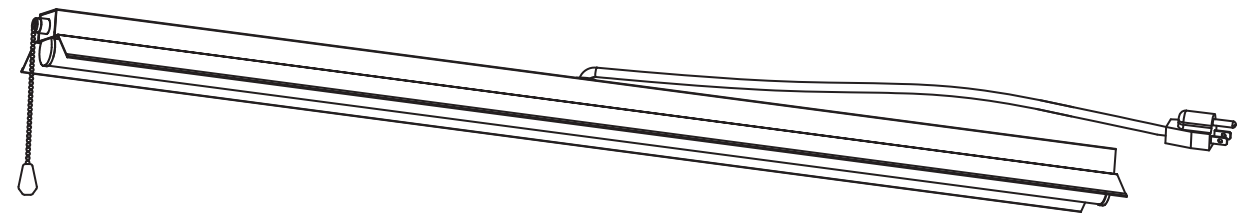

3-FT Shop Light

Installation Instructions



ATTACH YOUR RECEIPT HERE

Item Number _____ Purchase Date _____

Questions, problems, missing parts? Before returning to your retailer, call our customer service department at 1-866-492-6566.

PACKAGE CONTENTS

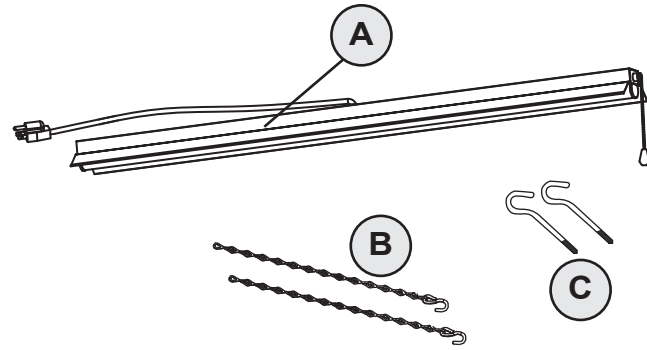

Part	Item Name	Qty.
A	Fixture	1
B	Chain	2
C	"J" Hook	2

SAFETY INFORMATION

Please read and understand this entire manual before attempting to assemble, operate or install the product. Failure to do so could lead to electric shock, fire or other injuries that could be hazardous or even fatal.

- Be sure the electricity to the wires you are working on is shut off. Either remove the fuse or turn off the circuit breaker.
- Changes or modifications not expressly approved by the party responsible for compliance could void the user's authority to operate the equipment.
- This product must be installed in accordance with local, state and national electrical codes.
- Installation work shall be completed by a licensed installer that is familiar with the construction and operations of the product.

CAUTION:

- The fixture body is one piece. Do not disassemble it.
- This product can NOT be used with a dimmer switch.

NOTICE

- This device complies with Part 15 of the FCC Rules. Operation is subject to the following two conditions: (1) This device may not cause harmful interference, and (2) this device must accept any interference received, including interference that may cause undesired operation.
- This equipment has been tested and found to comply with the limits for a Class B digital device, pursuant to part 15 of the FCC Rules. These limits are designed to provide reasonable protection against harmful interference in a residential installation. This equipment generates, uses and can radiate radio frequency energy and, if not installed and used in accordance with the instructions, may cause harmful interference to radio or television reception, which can be determined by turning the equipment off and on. The user is encouraged to try to correct the interference by one or more of the following measures:
 - Reorient or relocate the receiving antenna.
 - Increase the separation between the equipment and the receiver.
 - Connect the equipment into an outlet on a circuit different from that to which the receiver is connected.
 - Consult the dealer or an experienced radio/TV technician for help.

INSTALLATION INSTRUCTIONS

1. Mark two (2) locations on mounting surface spaced apart by 24-in.
Ensure that the mounting holes will be located on a sturdy surface such as wood rafters, plywood or drywall studs. The mounting holes should NOT be located over a drywall surface without a backing support, as this may not provide enough support for the weight of the fixture.

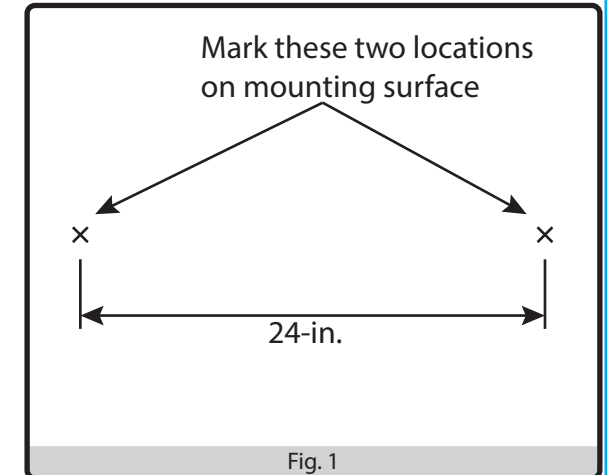

Fig. 1

2. Drill pilot holes in each of the two marked locations. Screw in the two "J" hooks (C), one in each pilot hole. Hook the loop end of one chain (B) onto each "J" hook (C).

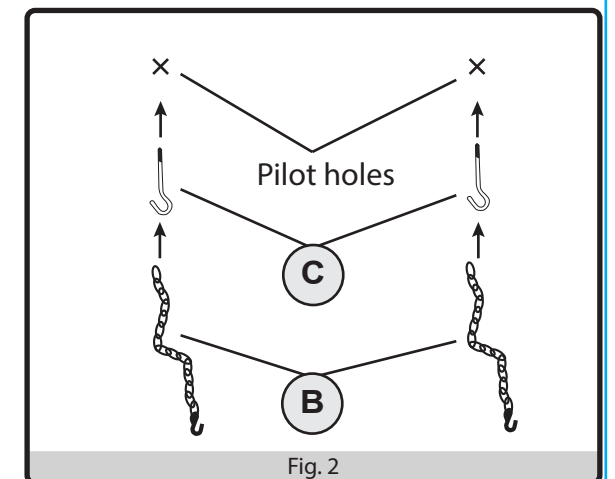

Fig. 2

3. Insert the hook end of one of the chains (B) into the support slots on the fixture back as shown in Fig. 3 to support the fixture on the mounting surface. Repeat for the second mounting hole.

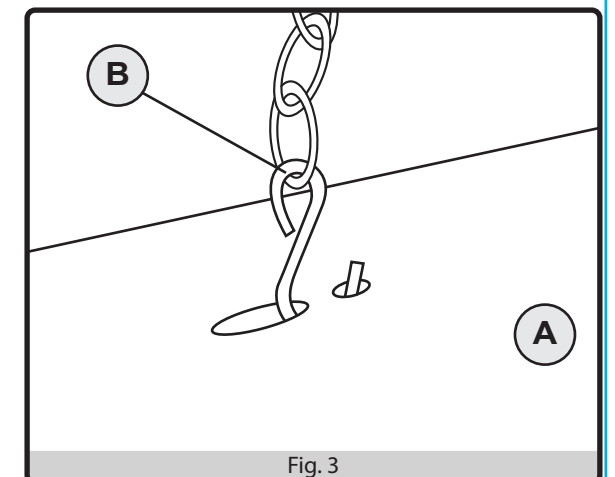
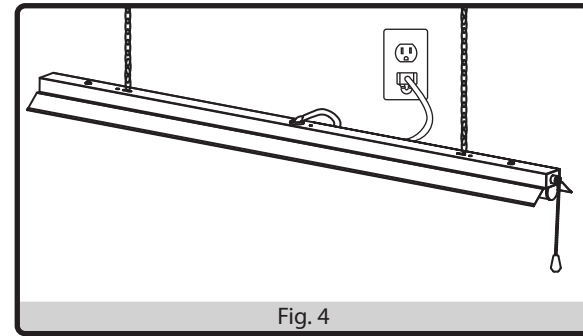

Fig. 3

INSTALLATION INSTRUCTIONS

4. After mounting the fixture plug the power cord into a grounded outlet to finish the installation.



OPERATING INSTRUCTIONS

1. The fixture is powered on and off by pulling on the Power Pull Chain.

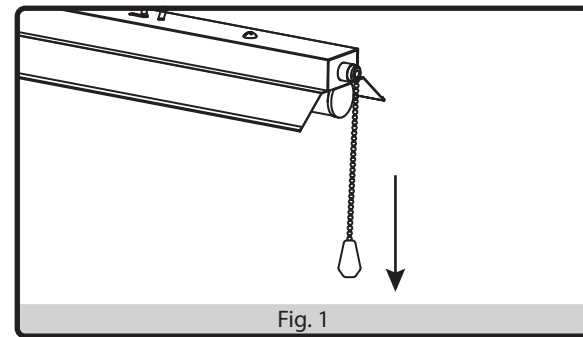

CARE AND MAINTENANCE

Clean with a mild, non-abrasive glass cleaner and soft cloth. Do NOT use solvents or cleaners containing abrasive agents. When cleaning the fixture, make sure the power is turned off, and any liquid spray should be applied to the cleaning cloth and not sprayed directly onto the fixture itself.

TROUBLESHOOTING

Problem	Possible Solution	Corrective Action
Fixture does not light.	Power is off.	Check circuit breaker or wall switch.

WARRANTY

This fixture is warranted to perform free from defects for three years. If it fails to do so, you may return it with proof of purchase to 13445 12th St., Chino, CA 91710 for replacement.